

SPECIFICATIONS

(Typical values stored at 20°C for one year)

◆ Nominal capacity (at 1mA/20°C/68°F/2.0V cut-off)	1.65Ah
◆ Nominal voltage	3.6V
◆ Max. recommended continuous current (Higher current can be available upon consulting)	40mA
◆ Max. pulse current capability ★	90mA
◆ Operating temperature range	-55 ~+85°C
◆ Lithium metal content	approx. 0.5g
◆ Weight	12g
◆ Volume	5.5cm ³
◆ UL Approval	MH28122

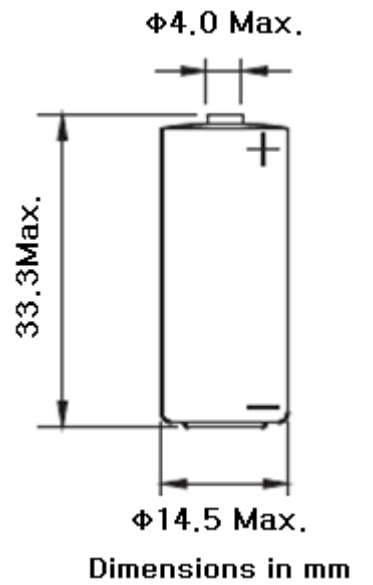

Available Terminal Type

STD, T1, T2, T3, T3/R, T3EU, T3EU/R, AX, Wire, Connector

Storage Condition

Please store batteries at clean, cool (not over +30°C), dry and ventilated condition

Max Pulse Capability: Maximum Pulse capability reading over 3.0V at 90mA/0.1sec. every 2 min. at +20°C, 10μA / cm² base current with fresh batteries. The pulse capability can be different to the cell status, environment. For max. pulse coverage, capacitor support is recommended.

